

EXTENDED MEMORY SYSTEMS I've had the opportunity to use the two extended memory systems - The Blue Ram and The Viper 1 - this past month, though not as much as I would have liked. Actually, the efforts has gone into using the Extended Basic Language we now have in each format, so I have been playing with circles, and snapshots... Recall that the Blue Ram version is on a cartridge, so that none of the Blue Ram available memory space is taken up with the language. Programs can be entered directly when the machine is turned on. The cartridge version allows inputs at either 300 or 2000 baud rate (use :INPUT and the attached tape recorder jack for the 2000 baud program, or :INPUT300 and the old cassette interface for a 300 baud program.) Of course, outputs are done in a similar fashion. Also available is the *PRINT function, which allows printer operation.

In the other version, the Viper arrived with a couple of taped programs, and I entered these into the Blue Ram to see how they would work, and also to get the printing done. With regard to the Viper, its Extended Basic arrives on a tape to be loaded prior to utilization. This loading takes about 8 minutes. At completion of your first successful loading, Alternative Engineering recommends that you make some duplicate tapes using your own recorder, which is an excellent idea. The three other programs were:

- 1) A checksum program that is used to prove that you have a proper loading of the program, by calculating the sum of all the bytes in each 128-byte block. Each sum is about 15000. They provide a set of answers for each of the 63 blocks checked.
- 2) A graphics display program that acts as a sort of dictionary of the available commands, with illustrations of many of them.
- 3) A short display program that superimposes circles and boxes, in four colors, in a sort of kaleidoscope effect.

I must admit to a certain amount of laziness, as I plugged the Blue Ram Extended Basic Cartridge into the Viper to have instant turn-on, and avoid the long wait of loading the tape. And contrari-wise, I loaded the Viper's tapes into the Blue Ram system to avoid having to key in the data.

Both systems have their positive and negative features in detail, but in overall operation, etc., they are quite parallel, both doing essentially the same thing. I was very pleased to see that I could do the cross-over things mentioned above.

BUSINESS PROGRAMS NEEDED We occasionally receive a request for some sort of business program, a sort of difficult thing to do with the limited memory available in the Arcade. Those of you with a talent for accounts receivable and that kind of thing should be able to generate something using one or the other of the memory addition systems now available - (the Blue Ram and the Viper).

ZGRASS - the language of the Add-Under. We reported on p. 13 of Vol 3, of the availability of the DATAMAX UV-1 computer, which utilizes Dr. DeFanti's Zgrass language. The November issue of Creative Computing has an interesting article by one of the purchasers of the UV-1, and his experiences with the language. Note that some of the feature commands (SNAP, CIRCLE) are available in the Extended Basic, offered by both Blue Ram and Viper manufacturers.

ASTROVISION BASIC is the new Basic cartridge now appearing on the market. The original Bally Basic is not going to be generally available any more (we have a few here).

We will certainly continue to support the older basic because there is a large world out there with them. Fortunately, the conversion required is quite minimal, and unless we identify otherwise, you can assume that whatever we print will work on both basics. We will use BB to identify Bally Basic and AB to identify AstroVision Basic programs where necessary. A similar code will be used when we list programs in Extended Basic or Zgrass languages.

CONVERSION of formats. What I'm speaking about here is the method of changing a program written in Bally Basic that tape-loads at a 300 baud rate into the AstroVision Basic tape loading rate of 2000 baud. The manual that comes with the AB cartridge has a program in machine language that does this. In essence, one enters this program into the AB cartridge by means of a tape and the:RUN command. Then the BB program is tape-loaded into the BB cartridge, one key is pressed and presto! the job is done. The program can now be tape-loaded at the 2000 baud rate. The manual wisely suggests that you make a number of copies of this conversion program for safe-keeping. At the moment, we prefer that all programs be submitted in Bally Basic, as we have not found a method to *PRINT an output to a printer in the AB format. (hackers take note)

MACHINE CODE PROGRAMMING is feasible using Bally Basic by going through some relatively inefficient ways to input the required data, segments of which have appeared in the ARCADIAN over the past three years.. This has been resolved by the Bit Fiddlers, who announce the availability of a new cartridge that will do all the work for you. See their ad.

This cartridge is intended to be a tool for the serious programmer and hardware type ('hacker'). A certain amount of familiarity with machine language principles (hex notation, how to look up instruction codes in microprocessor manuals, etc.), would allow a user to work with it almost immediately. The manual supplied with it is an attempt to bridge some of the gap between the novice and the experienced machine language type, but is not meant to take the place of a Z-80 programming handbook. Likewise, publications having information on the Bally on-board routines are a must if one plans to use the Machine Language Manager effectively. These routines are available in the document 'Executive Software', developed by Tom Wood, at \$3.00 first class, from the ARCADIAN.

In order to get a reasonable listing on the TV screen, the MLM uses its own 3x5 character set (very similar to that used in the Extended Basic). This smaller set places 39 characters on a line, but eats up a lot of memory in the unit. What is left is support of a printer and external keyboard through the cassette interface and the ability to produce self-starting program tapes.

Next in line will be game tapes to go along with the cartridge, with the first due in January. Then utilities to add to the machine language toolbox, and if enough people who have a keyboard also want a word processor, then a rudimentary one could be developed.

The Chicago group will have a copy at their next meeting for members' review.

Home Video Game Invasion Has Begun

By Dan Dorfman

You probably never heard of Astrovision, Inc. and there's no reason you should have; located in Columbus, Ohio, it's a mere 14½ months old, privately owned and its sales last year were just over \$1 million. But its investment implications — based on what's happening to the company's business — are enormous. And obviously a number of corporate biggies think so. Example: International Telephone & Telegraph is quietly talking to the company about a joint venture in Europe. CBS, a little over a month ago, held hot and heavy talks that might have led to its acquiring the company. And RCA also looked into a joint venture with the firm.



Mr. Dorfman

The reason for all this interest: tiny Astrovision is in probably the hottest growth business in the country — the exploding home video game field.

In August of '80, Astrovision acquired the rights to the home video business of Bally Mfg. Co. — a video machine which attaches to the TV set, plus 25 software packages of various games — for \$2.3 million, plus royalties.

To date, the company's business has been going through the roof. Astrovision vice president Ray George estimates '81 sales at between \$12 million and \$15 million — with net profit running a little over \$1 million. And with a current order backlog of about \$55 million, he figures '82 should produce at least \$100 million in sales and around \$10 million in net earnings.

As George sees it, "There is a game craze over the country, in fact all over the world, and we intend to be a leader in it."

George regards the Bally sale of its home video game business to Astrovision as a "giant blunder" and suggests the company goofed badly by treating the operation as a stepchild.

He may be right, but Bally, which is the kingpin in the arcade and coin-operated pinball and video game business, is apparently taking steps of remedy that.

Sources tell me that Bally, within the next 60 days, will announce its intent to produce software packages expressly for home video machines.

Whether Astrovision — which talks optimistically of going public in early '82 and being a billion-dollar company in '85 — continues to achieve meteoric growth, and in fact even survives in the face of the almost certain surging competition, remains to be seen.

"If you tie in the personal computer, which is what many people will use to play these games, this home video revolution will be the single hottest investment area over the next three to five years," predicts Lee Isgur, Wall Street's top entertainment specialist.

The 44-year-old Isgur, an analyst at Paine Webber Mitchell Hutchins, tosses out some glowing numbers to support his case. By 1985, he figures hardware sales — the game machines which currently retail at \$199 to \$299 (although there's heavy discounting) — will represent a worldwide volume of between \$5 billion and \$10 billion; software, (generally \$20 to \$25 a cartridge), \$5 billion to \$15 billion.

FINANCIAL NEWS The above column was included in a number of financial pages of the country's newspapers on Oct. 29. Mr Isgur appeared on the PBS TV show, Wall Street Week on November 20, at which time he included Bally as one of his three 'buy' recommendations.

Z-80 MACHINE LANGUAGE?

That's right! A NEW cartridge for programming the BALLY ARCADE entirely in Machine Language. Now you can have:

- Fast graphics--Better animation
- 4 colors instead of 2
- More efficient memory usage
- The capability to produce Cartridge Quality program tapes*
- Easier access to all on-board subroutines
- Complete control over all facets of the BALLY ARCADE

All this and MORE with the

Machine
Language
Manager
for the
Bally® Arcade



\$54.95 †

From

The Bit Fiddlers
P.O. Box 11023
San Diego, CA 92111-0010

*Cassette requires 300 Baud interface.

† Includes postage & handling.
Calif. residents add 6% sales tax.

Super
oftware

BOX 702
PLAINFIELD, NJ 07061

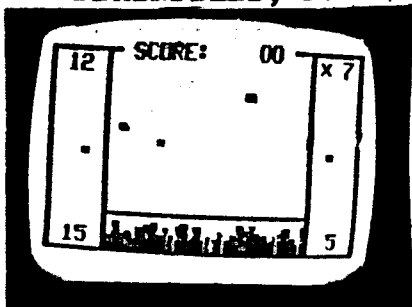

Tape
10

Falling Stars!

Radiocative stars are decending onto the city below. If the city is hit, many lives will be lost. It's up to you to protect the city by destroying the stars before the reach the surface. If you enjoy 'Missile Command', you'll love 'Falling Stars' by Super Software. The speed and graphic will astound you. Also includes 'Laser Battle'. Only \$10.00 from Super Software. Order yours and have hours of fun.

Send For Free Catalog

I-O SWITCH FOR NEW BALLY BASIC CARTRIDGE

by Steve Walters

The new Bally (Astrovision) Basic cartridge has a single audio jack for tape input-output. This requires the operator to switch the audio cable back and forth between the tape recorder's "mike" jack for output (:PRINT) and the "ear" jack for input (:INPUT). This cable switching is a nuisance, and is easy to forget.

I have overcome this by providing a switch on my computer to eliminate the physical switching of the audio cables. This required a modification of my tape recorder also.

Computer-mounted switch. Mount a double-pole double-throw (DPDT) miniature-size switch (like Radio Shack No. 275-614) at a convenient location on the computer case. Make sure there is room inside the case for the switch and its wires to clear other components.

Run three audio cables through holes at convenient locations in the case and connect to the switch as shown in the illustration. Note that Cable B must be long enough to reach the jack on the New Bally Basic Cartridge, and Cables A and C must be long enough to reach your tape recorder. A good source for the audio cables is a six-foot extension cable with a miniature phone plug on each end (like Radio Shack No. 42-2420) which can be cut in half to make two of the required cables.

A variation which may be preferred for some equipment set-ups is to connect Cables A and C from the switch to miniature phone jacks (center wire to lug #1 and shielding to lug #2) mounted in the side of the computer case. The computer can then be connected to the tape recorder by audio cables with plugs on each end.

Tape recorder modification. The normal "ear" jack on a tape recorder provides a signal during playback for private listening, and also during recording for monitoring the mike input. This signal interferes with the "mike" signal when both cables are plugged in while using the New Basic cartridge, and prevents a clear recording of the computer's output. We need an "ear" jack which receives a signal from the tape recorder only during playback, and this is available from the speaker output, since it is activated on playback but not during recording.

Mount a closed-circuit type miniature phone jack (like Radio Shack No. 274-253) on the tape recorder case, near the "mike" jack if possible. Again, make sure there is space inside the case for the jack to clear other components. Then wire as follows:

- (1) Unsolder either one of the two wires from the tape recorder's speaker, and connect it to lug #2 on the new phone jack (see illustration).
- (2) Connect a wire between lug #1 of the phone jack and the speaker lug which still has a wire on it.
- (3) Connect a wire between lug #3 of the phone jack and the speaker lug from which you removed a wire in Step (1).

This "new ear" jack receives a signal only on playback, and turns the speaker off when the cable is plugged in. The normal operation of the recorder is not affected. Plug audio Cables A and C into the tape recorder's "mike" and "new ear" jacks, and label the computer-mounted switch ":INPUT" and ":PRINT" according to how you plugged in the cables. A little red paint on the "mike" cable will remind you which cable is which, just like the Old Basic Interface cables.

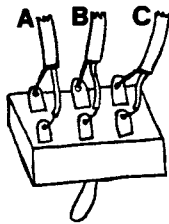

Computer-mounted Switch

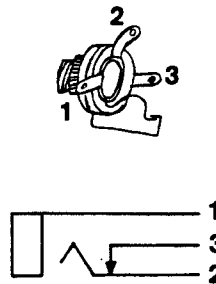

"New ear" jack in tape recorder

Parts List:

2 Extension cables (mini plug to mini plug)	Radio Shack No. 42-2420	\$2.29 each
3 Mini phone jacks (closed-circuit type)	Radio Shack No. 274-253	\$1.39 for 3
1 DPDT mini switch	Radio Shack No. 275-614	\$2.19
Plus a little wire and solder.		

ARCADIAN

```

1 .
2 .RND (ART)
3 .BY SUPER SOFTWARE
4 .BOX 702
5 .PLAINFIELD, NJ 07061
6 .
7 .PRESS 'GO' TO CLEAR
8 .
9 CLEAR
10 X=RND (42);LINE X,X,4;LINE -X,X,3;LINE X,-X,3;LINE -X,-X,3;LINE X,X,3
15 IF &(23)RUN
20 Y=RND (42);LINE Y,Y,4;LINE Y,-Y,3;LINE -Y,Y,3;LINE -Y,-Y,3;LINE Y,Y,3
30 IF RND (7)=1BC=RND (256);FC=BC+12+RND (8)b32
40 IF RND (5)=1A=RND (8)b10;BOX 0,0,A,A,RND (2)+1
50 IF RND (5)=1GOSUB 100
60 GOTO 10
100 A=RND (20);B=RND (20);C=RND (20)b2;BOX A,B,C,C,3;BOX -A,B,C,C,3;BOX -A,-B,C
,C,3;BOX A,-B,C,C,3;RETURN
150 LINE -Y,-Y,3

```

SAFETY MESSAGES are presented to McCormick & Co. employees in the Baltimore plant of the spice-producing corporation by means of a Bally Arcade. Subscriber Lou Gubernatis programs his Arcade with applicable safety messages and encloses them in an attention-getting visual display which is then placed on the cafeteria television screens by means of video tape. The company is quite enthused over the increased effectiveness of Lou's approach.

MICRO MEMORY EXPANSION is illustrated below. This schematic will enable you to add 1K of static RAM to the Arcade, courtesy of Mark Keller. This is probably the limit of addition that can be supported by the existing power supply.

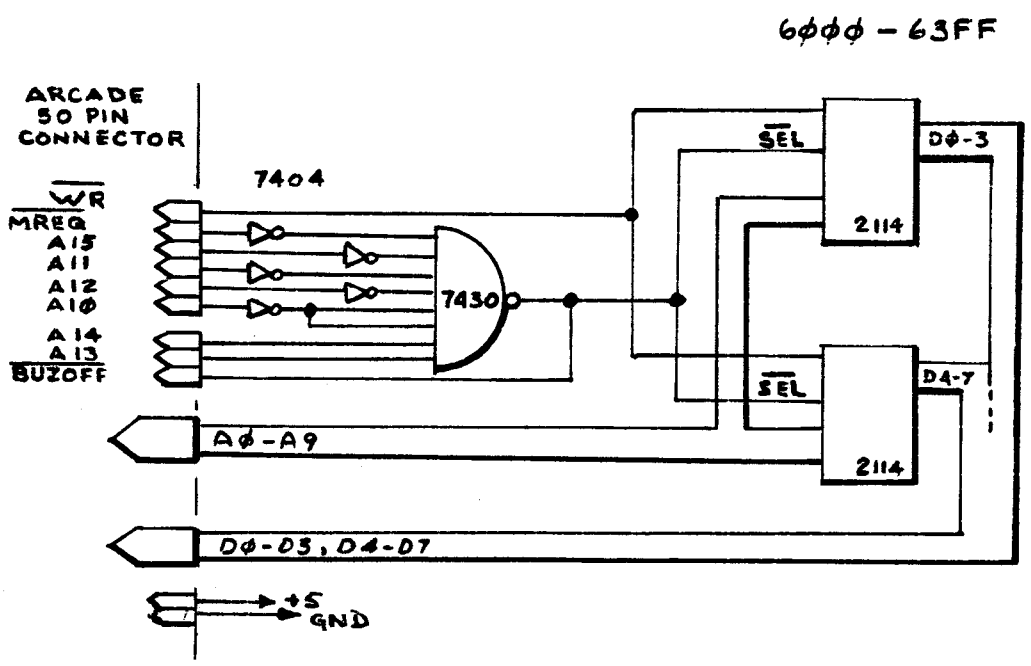

PRINTED MATERIAL that has been obtained over the last three years is listed below. Copies are available at the costs indicated, postpaid. Some of our more technically oriented subscribers have been successful in digging into the hidden areas of the Bally system, and have agreed to share their findings with us.

- o EXECUTIVE SOFTWARE, or a listing of the ROM cartridge, as disassembled by Tom Wood. Part of the document lists the ROM subroutines that are executed by an RST 3BH instruction, while the second part contains the listings from 0090-1FFF 27 pages, \$3.00

- o BASIC CARTRIDGE LISTINGS - The Tiny Basic cartridges taken apart by Tom Wood : the Bally Basic listing is 63 pages, \$7.00; while the AstruVisioB Basic is 70 pages, \$7.50 Operating instruction (not the Manual that comes with the cartridge) \$2.50

- o BALCHEK A program was developed by the Bally software engineers which 'looked at' the operation of the printed circuit board and determined if all was well, or it would identify the problem area. The program was entered into a 2716 chip, and a couple of 7-segment LED drivers and LEDs added to make up a package. All boards were inspected by this machine prior to insertion into the box. Tom Wood ran this through his disassembler and provided us with the listing, while I have added the sparse instructions. 60 pages, \$7.00 (NOTE - Dick Belton 301-488-2806 can provide either the ROM cartridge or complete unit.)

STEREO
COLOR ORGAN,
LIGHT SHOW
ON YOUR TV,
INTERFACE
WITH BALLY

OPTO-ISOLATED
ALL COLORS
BRILLIANT DISPLAY

*Color Organ/Light Show:
Interface Bally Astrovision to
any Stereo Speakers, creating
New Visual / Musical Forms.*

*Interface unit with Cassette Demo.
and instructions \$39.95..*

*Implement your own creative ability!!
The Light Show has a Money Back Guar.*

*We have 24 games on Cassette for
Bally Astrovision to choose from on
either of the Basic formats.*

*Write for our new fall 81 catalog
Its illustrated and FREE!!!*

L & M SOFTWARE
8599 FRAMEWOOD DR
NEWBURGH IN. 47630

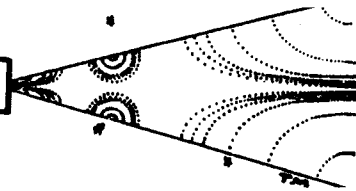

EXTENDED MEMORY is mentioned a number of times, and will be even more so as time goes by. Two major problems exist with the Arcade - the lack of a full size keyboard, and the extremely small memory (1.8K). Some very clever programming has taken place over the last three years to work around the memory problem, but there is no substitute for memory space. To alleviate this, Perkins Engineering brought out the Blue Ram 4K memory addition, which is housed in a small blue box that attaches directly to the 50-pin expansion connector at the back of the Arcade (snap out the segment between the two inner hand controller ports). In addition, a keyboard can be attached to the Blue Ram to overcome the other shortcoming. A second company, Alternative Engineering, is also providing a memory addition on a larger scale, with a 16K RAM in a relatively large box that allows for future additions. It too has an attachable keyboard. Each of these vendors also makes available a new language for the Arcade, generically called "Extended Basic". This language is essentially identical between the two vendors so that programs written on one system will operate on the other. There are some operational differences, the Blue Ram version is provided on a ROM cartridge while the Alternative Engineering version is on a tape. We will be supporting this language with programs, tutorials, etc., as we do the two Tiny Basics. Both vendors frequently advertise in the ARCADIAN,

>*PRINT ;LIST

- 1 . " VIPER TEST PATTERN "
- 2 . AN EXAMPLE OF THE NEW EXT. BAS. 1.0
- 3 . ALTERNATIVE ENGINEERING
- 4 . P.O. BOX 12B
- 5 . GARDINER , MAINE 04345
- 6 .

This is one of the VIPER programs that demonstrates Extended Basic. Those of you with the Blue Ram Extended Basic can get a colorful display with this...

```
10 CLEAR ;BC=0
30 DATA A,0,0,0,0;E=RND (7)
40 FOR Z=1TO RND (25)+15STEP RND (2)+1
50 CIRCLE 0,0,Z,E+1;CIRCLE 0,0,Z-10,E-1;CIRCLE 0,0,Z+10,E+2;BOX -A,B,C,D,E;BOX A,-B,C,D,E;BOX 0,0,Z-15,Z-15,E-2;BOX -A,-B,C,D,E;BOX A,B,C,D,E;A=A+2;B=A-1;C=C+2;D=C;NEXT Z
60 GOTO 30
```

NUCLEAR MATH additions were sent in by Don Gladden, to supply the constants that are needed. After loading the program, type in the following without using a line number:

```
C=30;M=20;O=34;P=28;R=29;V=470;W=32;Y=1000
```

Then run the program. Now, since the constants above are not part of the program listing, they won't print out if you use LIST or PRINT. If you want to save this program on tape, you will have to also load the constants. To do this, type in

```
:PRINT;NT=1;LIST;PRINT"C=30;M=20;O=34;P=28;R=29;V=470;W=32;Y=1000;:RETURN;RUN
```

and then press GO to get the program listed to tape.

STARFIGHTER sets the screen up as a viewport to space, where an even dozen alien ships are waiting for you. You will see a set of crosshairs, and then an alien ship will appear. Move the joystick in the direction of the ship to line up the ship in the sight. Pull the trigger to fire. You can only get a hit if the ship is in dead center (not easy at all) You are in trouble if your shields get to 0%, or the temperature goes up to 100.

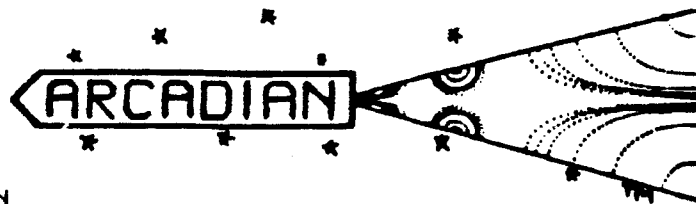

```

1 .
2 .STARFIGHTER
3 .BY JAMES WINN
4 GOTO 30
5 &(16)=0;&(19)=0;&(20)=0;&(21)=0;&(23)=0;RETURN
30 CLEAR ;NT=0;BC=23;FC=0;A=12;B=100;C=1001;D=0;E=0;F=0
40 CY=39;PRINT "FUEL          SHIELDS 100%"
50 CY=-39;PRINT "TEMP
60 X=162;Y=69;FOR Z=1TO 5;X=X-2;Y=Y-2;BOX 0,0,X,Y,3;NEXT Z
70 FOR Z=-10TO 10;BOX Z,0,11,1,3;BOX 0,Z,1,11,3;NEXT Z;BOX 0,0,15,15,1;GOTO 39
0
80 X=RND (100)-50;Y=RND (40)-20;G=RND (4);IF G#1GOTO 130
90 BOX X,Y,8,2,3;BOX X,Y-1,6,1,3;BOX X,Y,2,3,3;H=JX(1)b8;I=JY(1)b8;&(16)=200;&
(19)=3;&(20)=255;&(21)=1
100 IF TR(1)GOTO 330
110 IF X<10IF X>-10IF Y<10IF Y>-10H=JX(1)b2;I=JY(1)b2
130 IF F>82IF E=0E=1;CX=-6;CY=-39;PRINT "TEMP CRITICAL
140 IF F<83IF E=1GOTO 390
150 C=C-1;F=F-1;IF F<0F=0
160 IF C<0C=0
170 CY=-39;CX=-44;PRINT #1,F;CX=-40;CY=39;PRINT #1,C
175 IF A=0GOTO 470
180 IF C=0CY=39;PRINT "NO FUEL";GOTO 440
190 IF F>100GOSUB 5;CX=-6;CY=-39;PRINT "OVERHEATED!!!";GOTO 450
200 IF G#1FOR Z=1TO 200;NEXT Z;GOTO 80
210 IF RND (6)=1GOTO 240
220 IF TR(1)GOTO 330
230 BOX X,Y,8,2,3;BOX X,Y-1,6,1,3;BOX X,Y,2,3,3;X=X+RND (3)-2-H;Y=Y+RND (3)-2+I
235 IF (X>65)+(X<-65)+(Y>23)+(Y<-23)GOSUB 5;G=0;GOTO 200
237 GOTO 90
240 &(21)=255;K=X;L=Y;M=Xc8;N=Yc8;FOR Z=1TO 8;BOX K,L,Z,Z,3;BOX K,L,Z,Z,3;&(23)
=Zb10;K=K-M;L=L-N;NEXT Z;O=RND (3)
250 IF O#1FOR Z=9TO 33STEP 4;BOX K,L,Z,Z,3;BOX K,L,Z,Z,3;K=K-M;L=L-N;NEXT Z;GOT
O 280
260 &(16)=0
270 FOR Z=6TO 61STEP 11;BOX 0,0,Z+60,Z,3;BOX 0,0,Z+60,Z,3;NEXT Z;FOR Z=1TO 35;F
C=84;FC=0;NEXT Z
280 GOSUB 5;IF O#1GOTO 220
290 IF B=0BOX 28,39,70,9,3;GOTO 460
295 IF RND (4)=1B=B-10
300 F=F+11;B=B-10;IF B<0B=0
310 CX=50;CY=39;PRINT #1,B,"%";IF F>100GOTO 160
320 GOTO 230
330 GOSUB 5;C=C-50;F=F+11;&(19)=1;&(20)=7;&(21)=15
340 P=0;Q=-24;R=24;S=16;FOR Z=1TO 8;Q=Q+3;BOX P,Q,R,S,3;BOX P,Q,R,S,3;R=R-3;S=S
-2;NEXT Z
360 GOSUB 5;IF PX(P,Q)=0A=A-1;D=D+.00;GOTO 380
370 GOTO 310
380 P=1;Q=-1;&(21)=255;&(23)=255;FOR Z=1TO 6;P=P+2;Q=Q+2;BOX 0,0,P,P,2;BOX 0,0,
Q,Q,1;NEXT Z;BOX 0,0,15,15,1;GOSUB 5;E=0
390 CX=-6;CY=-39;PRINT #1,A," ALIEN",;IF A#1PRINT "S",
400 PRINT " LEFT";IF F>100GOTO 160
410 IF A=0GOTO 160
420 IF E=1E=0;GOTO 150
430 GOTO 80

```

James Winn
Box 98
Boiling Springs NC 28017

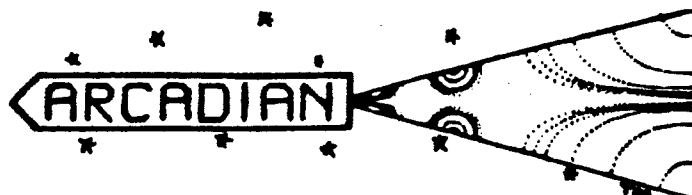

```

440 FOR Z=30 TO 122; BC=7; BOX -58,39,45,9,3; &(19)=Zb2; &(21)=15; NEXT Z; GOSUB 5; GOT
0 470
450 BC=83; FOR Z=1 TO 131; BOX 0, -39,160,9,3; &(16)=5; &(19)=210-Z; &(21)=15; NEXT Z; G
OSUB 5
460 FOR Z=1 TO 35; BC=0; &(21)=255; &(23)=255; BC=83; NEXT Z; GOSUB 5
470 IF A#0C=0
475 D=D+C+B-F; IF D<0D=0
480 BOX 0, -24,140,9,2; CX=-45; CY=-24; PRINT "YOUR SCORE", #5, D
490 IF TR(1) RUN
500 GOTO 490

```

Orbit Demo is a tutorial program for the space game programmers. You can see the results of the force of gravity on your spacecraft. Rem statements "." are included to show how the circle routines work. The following numbers will make an orbit or circle, X=0, Y=21, D=-6, E=0. There are several other combinations that will make different size orbits. Other number combinations cause elliptical orbits or wraparound takes effect. Have fun with this one. Program by Ron Picardi.

```

1 .
2 .
3 .ORBIT DEMO
4 .RON PICARDI
5 GOSUB 1000; CLEAR ; PRINT "TR(1) TO TRY AGAIN"; GOTO 100
10 .USE FOR MAIN BODY GOSUBS
20 &(17)=Xb2; &(18)=Yb4; RETURN
100 .MAIN BODY
110 BOX X,Y,5,1,3; BOX X,Y,1,5,3; .YOUR SHIP
120 U=X; V=Y; .SAVE OLD POSITION
125 .GRAVITY
126 BOX 0,0,3,3,3
130 IF X>0D=D-1
140 IF X<0D=D+1
150 IF Y>0E=E-1
160 IF Y<0E=E+1
161 IF X>75X=-75
162 IF X<-75X=75
163 IF Y>35Y=-35
164 IF Y<-35Y=35; .WRAP AROUND
165 X=X+D; Y=Y+E; .ADD NEW LOCATION
170 .REST OF PROGRAM
175 IF TR(1) GOTO 5
176 GOSUB 20
180 .ERASE AND RETURN
190 BOX U,V,5,1,3; BOX U,V,1,5,3; GOTO 100
1000 .SET ORBIT
1005 &(22)=0
1010 INPUT "INPUT X", X; INPUT "INPUT Y", Y
1015 INPUT "INPUT D", D; INPUT "INPUT E", E
1020 &(22)=200; &(20)=Xb2; RETURN
>

```

Sell Blue Ram unit with documentation and utility and diagnostic cassette. Asking \$150 for all, hardly used. Drew Davidson 4945 N.Calle Esquina, Tucson, AZ, 85718

ARCADIAN T SHIRTS Airbrushed Logo in full color. \$8. plus \$1 postage/handling. Send sizes and check to Don Gladden, 59400 Nine Mile Rd. So.Lyon, MI 48178

W & W Software Sales new address: 355 South Main St., Marine City, MI 48039

FOR SALE: Bally Arcade with 2 hand controllers, Bally Basic, and 11 videocades. Asking \$300. Terry Daly, 3048 So. Poplar, Chicago, IL 60608

ADD-UNDER NEWS - Late word has it that printed circuit board design is now undergoing verification, and then a small number of boards will be "stuffed" with parts and checked out. If all goes well, then production will get under way. Early 1982 still looks like a good date for this long-awaited hardware.

ARCADIAN
Robert Fabris, remembering '41
3626 Morrie Dr.
San Jose, CA 95127-9990

The SOURCE
TCD 959

